

**FIBERGLASS GRATING**

**VersaGrate<sup>™</sup>**

**YOUR VERSATILE  
GRATING SOLUTION**

**Molded Grating | Stair Products  
Pultruded Grating | Structural Shapes**

**877.GRIT.TOP  
www.versagrate.com**

# Versatility Defined

## STRENGTH

With one of the highest strength-to-weight ratios of any material, VersaGrate fiberglass grating is strong and durable, ready for years of dependable use. Unlike steel, VersaGrate has "memory", and will spring back to its original shape when deflected. Even major impacts inflict little damage with no failure. See our Load Rating Charts on pages 7 - 9 to choose a grid pattern and thickness to suit your particular application.

## CORROSION RESISTANCE

The key feature of VersaGrate fiberglass grating is corrosion resistance. With a variety of premium resin systems, VersaGrate fiberglass grating is the choice for a wide range of corrosive environments. It will not rot, rust or corrode, providing many years of use with little or no maintenance. No scraping or painting required. See our Corrosion Resistance Chart on page 10 to choose the resin system that is best for your application.

## SLIP RESISTANCE

Slip and fall accidents are the single most expensive and common type of industrial accident. Choose VersaGrate with either silica grit top or all resin meniscus top, and regain sure footing in slippery work areas. Water, oils, detergents, and food byproducts are no match for VersaGrate fiberglass grating, stair treads, stair covers and floor plate.

## FABRICATION AND INSTALLATION

VersaGrate fiberglass grating products are easily cut with standard power tools, using masonry or diamond embedded blades. We recommend using a worm gear driven circular saw, but standard tools can be used for most cutting. And there's no steel cutting, banding or welding which require specialized tools and often require facility permits. Fiberglass grating is lightweight and easy to handle, requiring no special lifting or installation equipment.

## FLEXIBILITY AND ERGONOMICS

Do your employees notice the hardness of their work floor surfaces? Does that contribute to on-the-job fatigue? VersaGrate fiberglass grating is naturally flexible, providing a comfortable, nonskid surface that is easy to stand on. An ergonomic work floor contributes to a better work environment by reducing fatigue and injury, thereby increasing productivity.

## LIGHTWEIGHT

Have you ever tried to lift a panel of steel grating without a crane or lift? Check the photo on the right. Two men can easily and comfortably lift a 4 foot by 12 foot panel of VersaGrate fiberglass grating. With an average weight of around 3 to 4 pounds per square foot, VersaGrate fiberglass grating is easy to carry and install. It's also easy to remove for maintenance access or cleaning underneath. Simply unscrew the clips and lift out. **No special lifting equipment required!**



## Standard Meshes

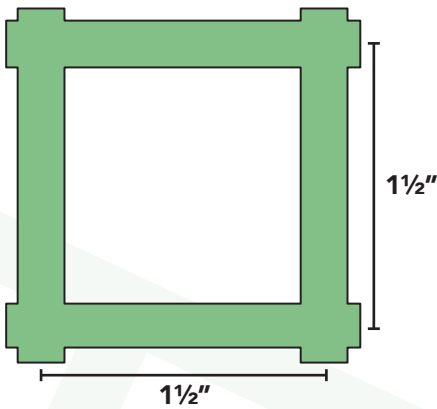

### 1 1/2" x 1 1/2" SQUARE MESH

# of Bars / Ft of Width: 8  
 Open Area: 70%  
 Load Bar Width: 1/4"  
 Load Bar Centers: 1 1/2"  
 Standard Depths: 1/2", 1", 1 1/4", 1 1/2"

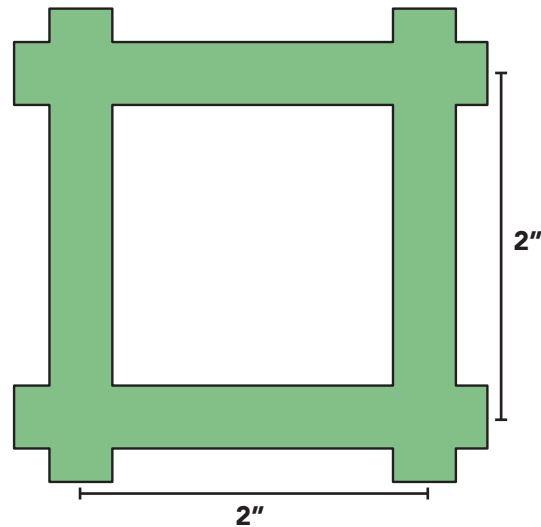

### 2" x 2" SQUARE MESH

# of Bars / Ft of Width: 8  
 Open Area: 72%  
 Load Bar Width: 3/8"  
 Load Bar Centers: 2"  
 Standard Depths: 2"

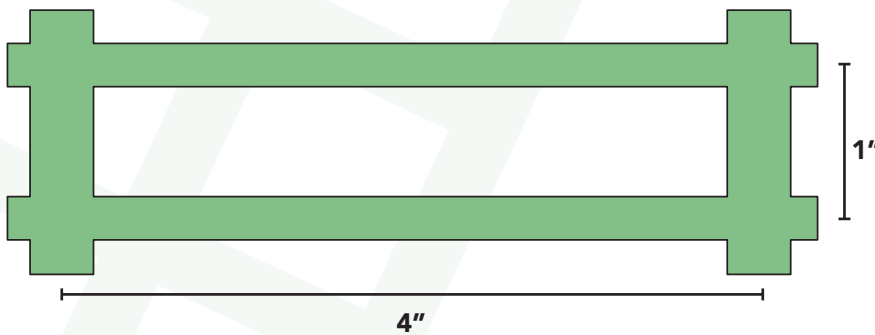

### 1" x 4" RECTANGULAR MESH

# of Bars / Ft of Width: 12  
 Open Area: 65%  
 Load Bar Width: 1/4"  
 Cross Bar Width: 3/8"  
 Load Bar Centers: 1"  
 Standard Depths: 1"

## Selection Chart

DEPTH	MESH	STANDARD PANEL SIZES	WEIGHT/SQ. FT.
1/2"	1 1/2" x 1 1/2"	4'x12'	1.25
1"	1 1/2" x 1 1/2"	4'x12', 3'x10'	2.5
1"	1" x 4"	4'x12', 3'x10'	2.8
1"	3/4" x 3/4"	4'x12'	3.4
1 1/4"	1 1/2" x 1 1/2"	4'x12', 3'x10'	3.2
1 1/2"	1 1/2" x 1 1/2"	4'x12', 4'x8', 3'x10', 5'x10'	4.0
2"	2" x 2"	4'x12', 3'x10'	4.82

Other meshes and panel sizes are available upon request. Please call for more information.



## Resins

VersaGrate offers a variety of resin choices to meet your corrosion control needs. For more information on what resin might work best in your application, please consult the Chemical Resistance Chart on page 10, or call for additional help.

**PFR-25:** A high-grade polyester resin for use in most applications where good corrosion resistance is required. ASTM flame spread rating of 25 or less.

**VFR-25:** A premium-grade vinylester resin for use in applications where extreme corrosion resistance is required. ASTM flame spread rating of 25 or less.

**FFR-35:** A food-grade polyester resin for use in the food, dairy, or meat packing industry. Food compatible ingredients are used in the fire-retardant additive, giving a flame spread rating of 35 or less.

Specialty resins are available upon request. Various resin formulas can be offered to meet different requirements for flame spread ratings, temperature ranges, and corrosion resistance.

Please refer to the Chemical Resistance Chart on page 10 for more information on resins. Please call for more details and to discuss your specific application.

## Surfaces

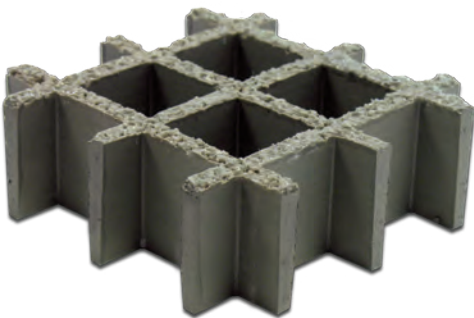

EMBEDDED GRIT

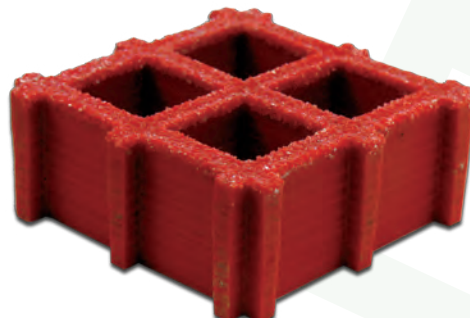

POST-CURE GRIT

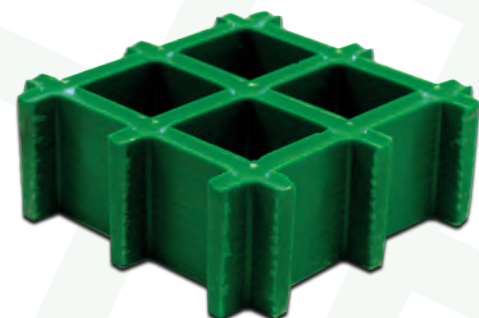

MENISCUS

Slip and fall accidents are one of the greatest dangers in an industrial environment, costing employers both time and money. VersaGrate offers a wide variety of anti-slip surfaces to help eliminate this danger.

**Embedded Grit:** Grit is added to the mold after the grating has been laid but not cured. Grit and resin are forced into the top of the grating and allowed to cure with the grating. A clean, durable grit surface.

**Post-cure Grit:** After the grating is cured and removed from the mold, grit is applied to the top of the grating with a strong adhesive. The grit surface is heat-cured with an additional top coat of adhesive for a maximum bond.

**Meniscus:** No grit is added to the surface after the grating is removed from the mold. A natural anti-slip, concave meniscus surface is formed during the curing process.

## Colors

An assortment of standard colors are available, including green, yellow, light gray, and dark gray. Special colors include orange, red, and blue. Custom colors are available by special order. Please call for color and grit samples.

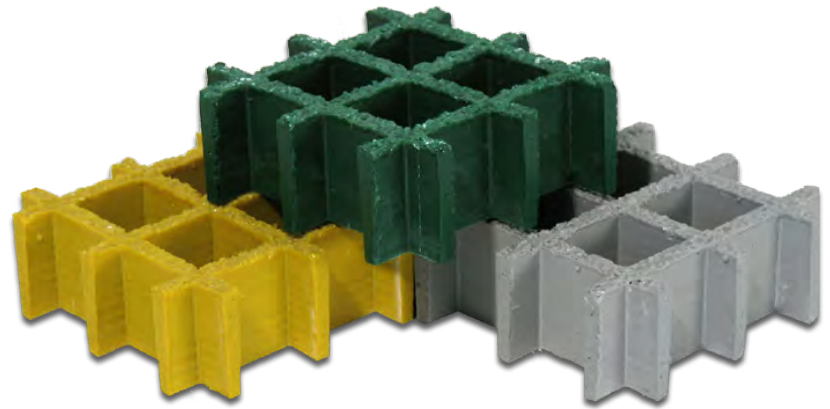

### STANDARD COLORS



### SPECIALTY COLORS



## Clips

VersaGrate offers a variety of specialty hold down clips to help secure our grating to structural supports. Each clip is specifically designed for our grating and plate products. All clips are made of 316SS for maximum corrosion resistance.

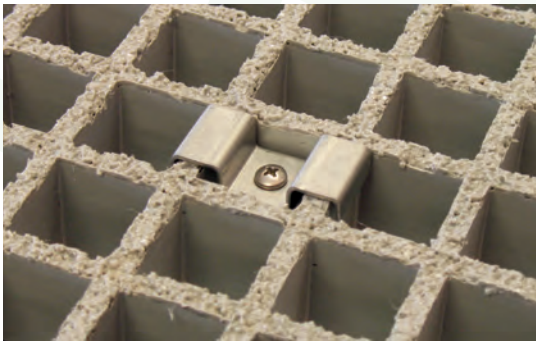

VersaGrate recommends placing clips every 48", using a minimum of 4 clips on any piece of grating and 8 clips on a full 4' x 12' panel.



M-CLIP



L-CLIP



F-CLIP



C-CLIP

## Clip Selection

STYLE	SIZE	USES
M-CLIP	1"	1" x 4" rectangular mesh grating
	1½"	1½" square mesh gratings and stair treads
	2"	2" square mesh gratings
L-CLIP	All Sizes	All molded grating. Grating thickness = clip size
C-CLIP	All Sizes	End panel clips. Grating thickness = clip size
F-CLIP	N/A	Covered grating, plate, pultruded and stair tread covers

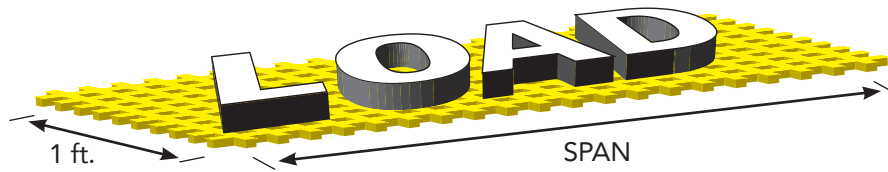

**Uniform Load Table – Deflection in Inches**

CLEAR SPAN	DEPTH	MESH	LOAD (lbs./square foot)						MAX CAPACITY
			50	100	200	300	500	1000	
12"	1"	1" x 4"	0.01	0.01	0.02	0.02	0.04	0.09	9,290
	1"	1½"	0.01	0.01	0.01	0.03	0.05	0.11	6,460
	1½"	1½"	0.01	0.01	0.01	0.01	0.03	0.05	9,900
	2"	2"	0.01	0.01	0.01	0.01	0.01	0.03	10,220
18"	1"	1" x 4"	0.01	0.02	0.05	0.07	0.11	0.24	4,580
	1"	1½"	0.02	0.04	0.08	0.12	0.22	0.40	3,150
	1½"	1½"	0.01	0.01	0.04	0.05	0.07	0.16	6,880
	2"	2"	0.01	0.01	0.02	0.03	0.05	0.10	6,710
24"	1"	1" x 4"	0.03	0.06	0.15	0.23	0.37	--	2,630
	1"	1½"	0.05	0.12	0.24	0.37	--	--	1,740
	1½"	1½"	0.02	0.05	0.07	0.12	0.22	0.45	3,895
	2"	2"	0.01	0.02	0.04	0.07	0.11	0.19	4,845
30"	1"	1" x 4"	0.07	0.17	0.35	0.58	--	--	1,680
	1"	1½"	0.15	0.26	0.61	--	--	--	1,110
	1½"	1½"	0.04	0.09	0.19	0.27	0.48	--	2,495
	2"	2"	0.02	0.05	0.10	0.15	0.24	0.45	3,270
36"	1"	1" x 4"	0.16	0.30	0.62	--	--	--	1,175
	1"	1½"	0.30	0.65	--	--	--	--	800
	1½"	1½"	0.10	0.19	0.39	--	--	--	1,755
	2"	2"	0.05	0.10	0.19	0.26	0.44	--	2,300
42"	1"	1" x 4"	0.34	0.75	--	--	--	--	850
	1"	1½"	0.50	--	--	--	--	--	555
	1½"	1½"	0.16	0.34	--	--	--	--	1,280
	2"	2"	0.09	0.16	0.33	0.49	--	--	1,675
48"	1"	1" x 4"	--	--	--	--	--	--	--
	1"	1½"	--	--	--	--	--	--	--
	1½"	1½"	0.26	0.51	--	--	--	--	1,080
	2"	2"	0.15	0.28	0.59	--	--	--	1,310

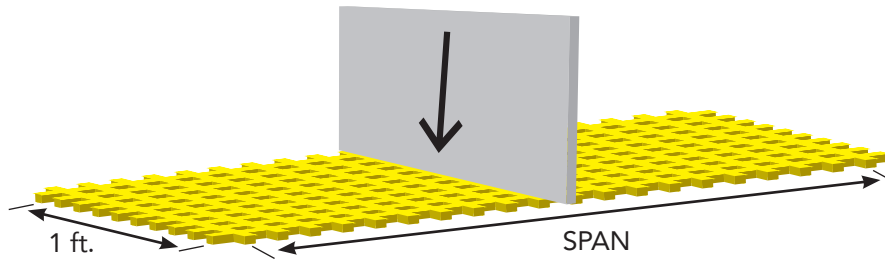

**Concentrated Line Load Table – 12” Wide Grating Strip – Deflection in Inches**

CLEAR SPAN	DEPTH	MESH	LOAD (lbs./foot of width)						MAX CAPACITY
			50	100	200	300	400	500	
12"	1"	1" x 4"	0.01	0.01	0.02	0.04	0.05	0.06	5,900
	1"	1½"	0.01	0.01	0.03	0.05	0.06	0.07	3,500
	1½"	1½"	0.01	0.01	0.01	0.02	0.03	0.03	10,750
	2"	2"	0.01	0.01	0.01	0.01	0.02	0.04	14,500
18"	1"	1" x 4"	0.01	0.03	0.07	0.11	0.16	0.18	3,700
	1"	1½"	0.02	0.04	0.08	0.12	0.17	0.20	2,500
	1½"	1½"	0.01	0.01	0.03	0.04	0.08	0.10	6,750
	2"	2"	0.01	0.01	0.02	0.03	0.04	0.06	7,000
24"	1"	1" x 4"	0.03	0.07	0.13	0.20	0.28	0.33	2,750
	1"	1½"	0.04	0.08	0.15	0.26	0.37	0.48	1,900
	1½"	1½"	0.01	0.03	0.06	0.09	0.11	0.14	4,950
	2"	2"	0.01	0.02	0.03	0.05	0.08	0.12	6,550
30"	1"	1" x 4"	0.05	0.10	0.21	0.29	0.39	0.51	2,370
	1"	1½"	0.08	0.17	0.36	0.51	--	--	1,520
	1½"	1½"	0.03	0.06	0.13	0.18	0.24	0.30	3,300
	2"	2"	0.01	0.03	0.07	0.10	0.13	0.16	4,200
36"	1"	1" x 4"	0.09	0.18	0.35	0.48	0.67	0.85	1,970
	1"	1½"	0.13	0.26	0.48	0.77	--	--	1,250
	1½"	1½"	0.04	0.08	0.17	0.24	0.30	0.38	3,300
	2"	2"	0.02	0.07	0.12	0.19	0.28	0.40	3,750
42"	1"	1" x 4"	0.15	0.31	0.49	--	--	--	1,625
	1"	1½"	0.20	0.41	0.79	--	--	--	1,075
	1½"	1½"	0.06	0.13	0.27	0.40	0.51	--	2,730
	2"	2"	0.02	0.07	0.12	0.19	0.28	0.40	3,750
48"	1"	1" x 4"	0.28	0.42	--	--	--	--	1,710
	1"	1½"	0.31	0.49	--	--	--	--	950
	1½"	1½"	0.10	0.21	0.39	0.59	--	--	2,800
	2"	2"	0.05	0.10	0.21	0.29	0.42	--	3,750

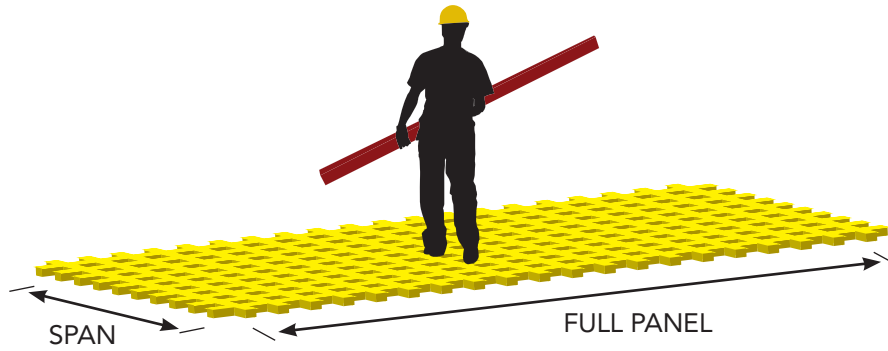

Concentrated Point Load Table – Deflection in Inches									
CLEAR SPAN	DEPTH	MESH	LOAD (lbs./square foot)						MAX CAPACITY
			50	100	200	300	500	1000	
18"	1"	1" x 4"	0.01	0.01	0.02	0.03	0.06	0.11	N/A
	1"	1½"	0.01	0.01	0.02	0.04	0.07	0.12	
	1½"	1½"	0.01	0.01	0.01	0.02	0.03	0.06	
	2"	2"	0.01	0.01	0.01	0.02	0.03	0.05	
24"	1"	1" x 4"	0.01	0.03	0.05	0.08	0.13	0.24	N/A
	1"	1½"	0.01	0.03	0.06	0.09	0.14	0.26	
	1½"	1½"	0.01	0.01	0.02	0.03	0.06	0.10	
	2"	2"	0.01	0.01	0.01	0.02	0.03	0.06	
30"	1"	1" x 4"	0.02	0.04	0.11	0.13	0.24	0.46	N/A
	1"	1½"	0.03	0.06	0.12	0.15	0.27	--	
	1½"	1½"	0.01	0.02	0.05	0.07	0.11	0.22	
	2"	2"	0.01	0.01	0.02	0.03	0.07	0.15	
36"	1"	1" x 4"	0.05	0.08	0.17	0.20	0.32	--	N/A
	1"	1½"	0.02	0.07	0.18	0.21	0.35	--	
	1½"	1½"	0.01	0.03	0.07	0.10	0.14	0.26	
	2"	2"	0.01	0.01	0.02	0.04	0.08	0.13	
42"	1"	1" x 4"	0.05	0.12	0.25	0.32	--	--	N/A
	1"	1½"	0.06	0.14	0.29	0.36	--	--	
	1½"	1½"	0.03	0.05	0.11	0.13	0.23	0.48	
	2"	2"	0.01	0.02	0.07	0.09	0.12	--	
48"	1"	1" x 4"	0.08	0.14	0.33	0.40	--	--	N/A
	1"	1½"	0.08	0.15	0.36	0.43	0.60	--	
	1½"	1½"	0.02	0.05	0.10	0.19	0.26	0.41	
	2"	2"	0.01	0.03	0.08	0.10	0.17	0.27	

NOTE: Load tables are for reference only. VersaGrate is not responsible for the use of these tables and cannot warrant the performance of grating through the use of these tables. Please call for assistance in the use of these tables.



# Chemical Resistance Chart

CHEMICAL ENVIRONMENT	CONC./ TEMPERATURE	TYPE PFR-25	TYPE VFR-25
Acetic Acid	50% / ALL	Constant	Constant
Acetone	100% / 75	Occasional	Frequent
Alum	100% / ALL	Occasional	Constant
Aluminum Chloride	100% / ALL	Constant	Constant
Aluminum Hydroxide	30% / 75	Occasional	Constant
Ammonium Chloride	100% / ALL	Occasional	Frequent
Ammonium Hydroxide	30% / 100	Not Recommended	Constant
Ammonium Sulfate	100% / ALL	Occasional	Frequent
Benzene	100% / 140	Occasional	Occasional
Black Liquor	100% / ALL	Occasional	Constant
Bleach Liqour	100% / ALL	Occasional	Constant
Calcium Hydroxide	25% / ALL	Frequent	Constant
Calcium Carbonate	100% / ALL	Constant	Constant
Calcium Hypochlorite	100% / ALL	Occasional	Constant
Calcium Nitrate	100% / ALL	Occasional	Constant
Carbon Tetrachloride	100% / 150	Not Recommended	Constant
Chlorine Dioxide	100% / 140	Not Recommended	Constant
Chlorine Water	100% / ALL	Occasional	Constant
Chromic Acid	35% / 150	Not Recommended	Frequent
Citric Acid	100% / ALL	Constant	Constant
Copper Chloride	100% / ALL	Frequent	Constant
Copper Cyanide	100% / ALL	Frequent	Constant
Copper Nitrate	100% / ALL	Frequent	Constant
Crude Oil	100% / ALL	Constant	Constant
Dichlorobenzene	100% / 75	Not Recommended	Not Recommended
Ethanol	50% / 100	Frequent	Constant
Ethylene Glycol	100% / ALL	Frequent	Constant
Ferric Chloride	100% / ALL	Occasional	Constant
Flouride Salts / HCL	100% / 75	Frequent	Constant
Formaldehyde	40% / 150	Occasional	Constant
Formic Acid	25% / 100	Occasional	Constant
Gasoline / Diesel	100% / 100	Occasional	Constant
Green Liquor	100% / ALL	Not Recommended	Constant
Hydrobromic Acid	50% / 150	Occasional	Frequent
Hydrochloric Acid	30% / 150	Frequent	Constant
Hydrofluoric Acid	20% / 75	Not Recommended	Frequent
Hydrogen Peroxide	30% / 150	Not Recommended	Constant
Lactic Acid	100% / ALL	Constant	Constant
Lime Slurry	100% / ALL	Constant	Constant
Lithium Chloride	100% / ALL	Not Recommended	Not Recommended
Magnesium Chloride	100% / ALL	Constant	Constant
Magnesium Nitrate	100% / ALL	Frequent	Constant
Magnesium Sulfate	100% / ALL	Constant	Constant
Maleic Acid	100% / ALL	Occasional	Constant
Mercury Chloride	100% / ALL	Frequent	Constant
Nickel Chloride	100% / ALL	Constant	Constant
Nickel Sulfate	100% / ALL	Constant	Constant
Nitric Acid	20% / 120	Frequent	Constant
Ozone (WWT)	100% / ALL	Constant	Constant
Oxalic Acid	100% / ALL	Occasional	Frequent
Perchloroethylene	100% / 75	Not Recommended	Frequent
Phenol	10% / 75	Not Recommended	Constant
Phosphoric Acid	85% / ALL	Occasional	Constant
Potassium Chloride	100% / ALL	Occasional	Constant
Potassium Hydroxide	10% / 120	Occasional	Constant
Potassium Nitrate	100% / ALL	Occasional	Constant
Potassium Sulfate	100% / ALL	Occasional	Constant
Silver Nitrate	100% / ALL	Occasional	Constant
Sodium Acetate	100% / ALL	Occasional	Constant
Sodium Bromide	100% / ALL	Occasional	Constant
Sodium Cyanide	100% / 75	Occasional	Constant
Sodium Hydroxide	25% / All	Not Recommended	Constant
Sodium Nitrate	100% / ALL	Occasional	Constant
Sodium Sulfate	100% / ALL	Frequent	Constant
Sulfur Dioxide	100% / ALL	Frequent	Constant
Sulfuric Acid	50% / ALL	Occasional	Constant
Tartaric Acid	100% / ALL	Frequent	Constant
Toluene	100% / 120	Occasional	Frequent
Trisodium Phosphate	50% / ALL	Occasional	Constant
Vinegar	100% / ALL	Constant	Constant
Water (Salt or Fresh)	100% / ALL	Constant	Constant
Zinc Chloride	100% / 75	Occasional	Constant

## VersaTread Stair Treads

VersaTread fiberglass stair treads combine the unique features of fiberglass grating with an easy-to-fabricate panel. Waste is virtually eliminated by the double-bar cutting channel conveniently spaced every six inches, leaving a solid bar on each side of the cut. No nubs to cut off between treads — no wasted grating!

Standard panel size is 1½" thick, 22¾" wide by 12' long with tread nosing on each side of the panel, allowing treads to be cut from both sides. Standard mesh is 1½" by 6".

All VersaGrate fiberglass stair treads utilize a gritted nosing for added slip-resistance. This nosing contrasts with the color of the stair tread, increasing visibility and reducing slip/fall accidents. VersaGrate fiberglass stair treads are available pre-fabricated and ready-to-install!

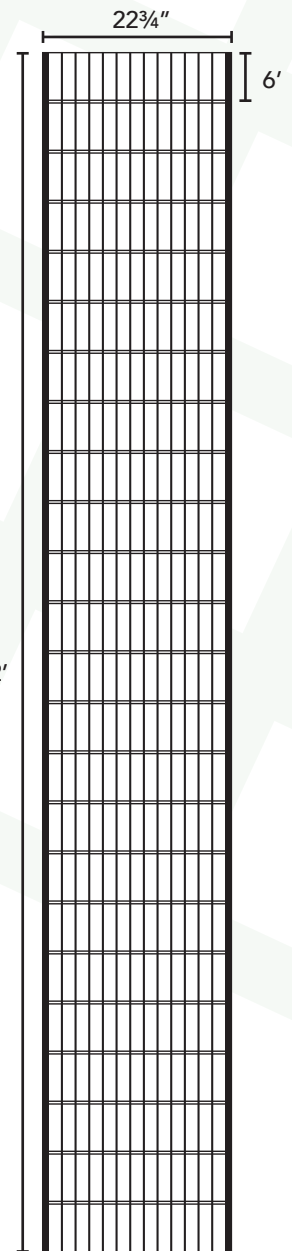

## Fabrication Guide

**For solid bars on all sides of the tread, use:**

- Standard Widths: Cutting channel spaced every 6" on center
- Standard Depths: 7⅞" 9⅜" 10⅞"



# Heavy Load Capacity Grating

VersaGrate's Heavy Load Capacity grating is an ideal solution for trench drains and other areas that need to hold up to forklift, car, or truck traffic, utilizing a tight mesh pattern and ultra heavy load bars. Compared to traditional metal trench grating, fiberglass Heavy Load Capacity grating is much lighter, allowing easy access to the trench below without special lifting equipment.

Heavy Load Capacity grating is available in 4' x 6' panel sizes, with the load bars running in the 6' direction (see diagram below). VFR-25 resin is standard to hold up to the most corrosive applications.

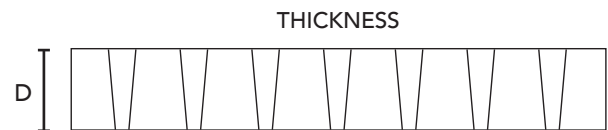
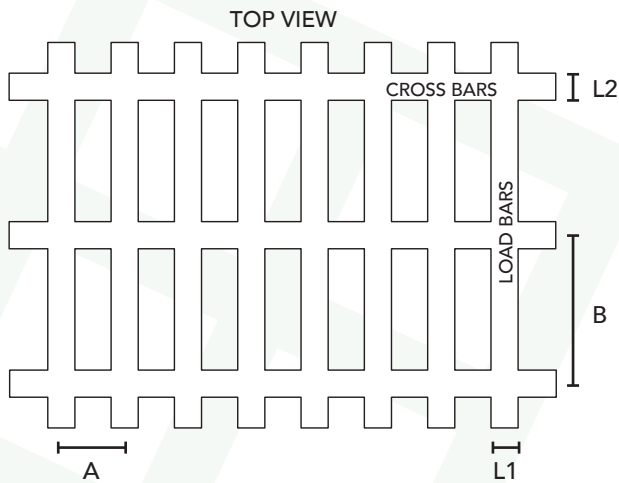

Dimension	Depth (D)	
	1½"	2"
A	1.0"	1.0"
B	2.0"	2.0"
L1	0.44"	0.53"
L2	0.40"	0.40"
Open Area	46%	46%
Weight	6.4 psf	8.7 psf

## Panel Layout:

Heavy Load Capacity grating is available in a 4' x 6' panel size, with the load bars running in the 6' direction. To cut a trench drain grating cover, simply cut in the 4' direction to whatever trench width is required. The resulting 4' piece is easy to carry and install, as well as easy to remove for future trench access.

VersaGrate recommends a minimum of a ¼" gap on each side of the trench and an ⅛" between each piece. All cuts should be sealed with a high quality vinylester resin for optimum performance.



## Load Tables:

LOAD TABLE TYPE	18" SPAN	LOAD: 200	LOAD: 500	LOAD: 1,000	MAXIMUM LOAD
CONCENTRATED LINE (LBS/FT WIDTH)	1½"	0.01	0.03	0.05	10,000
	2"	0.01	0.01	0.02	12,000
UNIFORM (PSF)	1½"	0.01	0.03	0.04	14,000
	2"	0.01	0.01	0.02	16,500

Load table is for reference only. VersaGrate is not responsible for the use of these tables and cannot warrant the performance of grating through the use of these tables. Please call for more information about the use of these tables, and for more load table data.



## Stair Tread Covers

VersaGrate fiberglass stair tread covers provide an excellent alternative to stair tread replacement, combining slip-resistance with corrosion resistance. Simply place the premolded cover over existing stairs and secure using VersaGrate's F-clip. It's quick, easy, and instantly transforms worn out or damaged stair treads.

The aluminum oxide grit surface provides an extremely slip-resistant stair tread, even when wet or oily, for maximum safety. The integral yellow nosing allows for higher visibility, reducing trip hazards and improving OSHA compliance, all done with a minimum investment.

The standard panel size for stair tread covers is 13½" deep by 12' long. Simply trim the panel to the desired depth and cut to the correct width. Plus, VersaGrate stair tread covers can be pre-fabricated to any depth and width, ready-to-install from the factory!

VersaGrate stair tread covers should be installed using mechanical fasteners to insure a positive connection to the tread underneath. Low profile head fasteners and washer style clips ("F-clips") are available in 316SS for installation (see below).

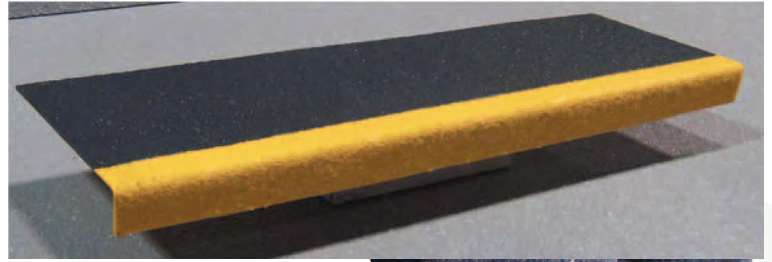

*Please call for more information on applications and installation.*



# Covered Grating

VersaGrate covered grating is a one-piece molded grating, combining the solid surface of plate and the structural support of molded grating. Covered grating is available in a variety of thicknesses, ranging from 1 1/8" to 2 1/8". Grit top surface is standard on all covered grating products, creating a safe walking surface.

Covered grating is ideal for applications where open-mesh grating is undesirable. Whether over a food process where items might fall through an open-mesh grating, or an area where fume containment is critical, covered grating meets the need for a solid surface decking that is both corrosion resistant and slip resistant. It is also useful in areas where cart wheels or shoe heels might otherwise have difficulty traversing open-mesh grating. The solid plate surface improves stiffness and load rating of the grating by up to 50%.

Covered grating is available in the same resin systems as our standard grating. Standard colors are green, light gray, and yellow. Custom resins and colors are available for special order.

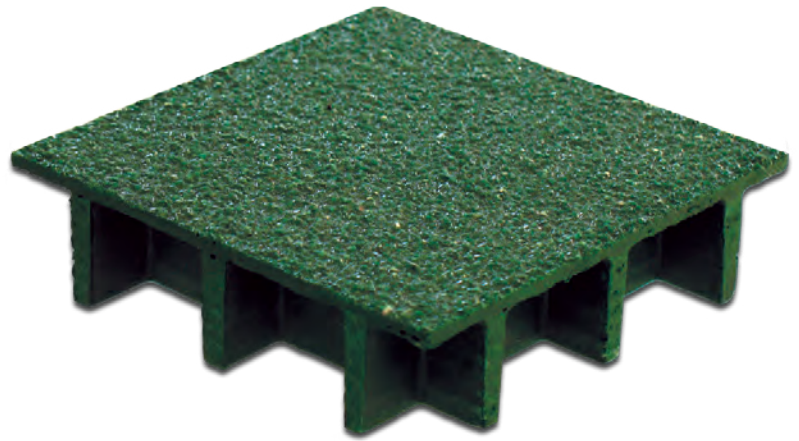

Total Depth	Mesh	Standard Panel Size	Weight Per Sq. Ft.
1 1/8"	1 1/2" x 1 1/2"	4' x 12'	3.85
1 5/8"	1 1/2" x 1 1/2"	4' x 12'	5.35
2 1/8"	2" x 2"	4' x 12'	6.15

Standard plate thickness is 1/8". Grit top surface is standard. Thicker plate, other panel sizes, and other options are available for special order.

## Fiberglass Plate

Whether installed over existing grating, or used as a non-slip surface over concrete or other solid surfaces, VersaGrate's fiberglass plate creates a durable and safe walking surface.

Fiberglass plate is made by laminating sheets of fiberglass mat with VersaGrate's high quality resin systems. Embedded grit top surface is standard on all plate products, providing an excellent anti-slip walking surface that is superior to diamond plate, as well as other solid plate products. Fiberglass plate is also lightweight and easy to cut, making installation easy and inexpensive.

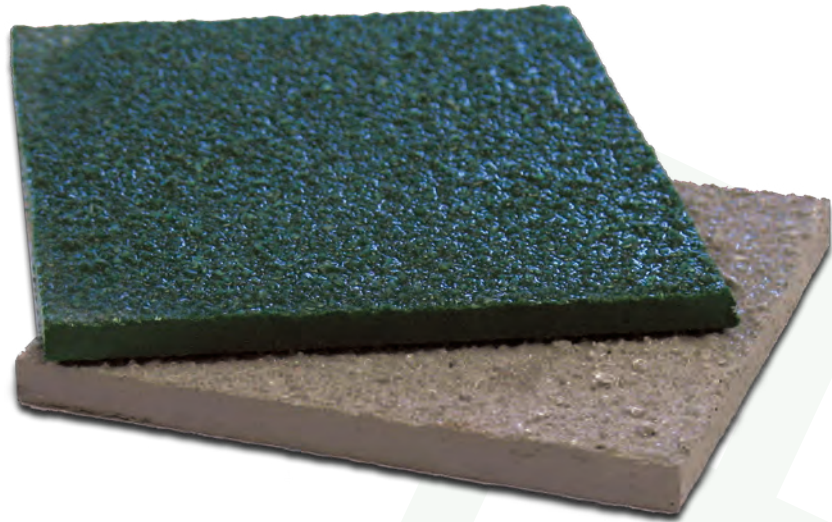

Fiberglass plate is available in the same resins and colors as our standard grating products. Custom colors, resins, thicknesses, and panel sizes are available for special order. See chart below for more information on standard sizes.

Both VersaGrate's fiberglass plate and covered grating should be installed using mechanical fasteners. VersaGrate's F-clips provide a solid anchor point, and eliminates tripping hazards associated with higher profile fasteners.

Thickness	Standard Panel Size	Part Number	Weight Per Sq. Ft.
3/16"	4' x 12'	M-PLATE-316-A	1.93
1/4"	4' x 12'	M-PLATE-14-A	2.60
3/8"	4' x 12'	M-PLATE-38-A	3.91
1/2"	4' x 12'	M-PLATE-12-A	5.45

Grit top surface is standard.

Other thicknesses, panel sizes, and options are available for special order.



## Pultruded Grating

VersaGrate pultruded grating combines the excellent corrosion resistance of fiberglass with the strength of structural shapes. To form the load bars of pultruded grating, continuous glass fiber rovings are pulled through a resin bath and formed through a die in the shape desired. These load bars are typically in the shape of an "I" or a "T".

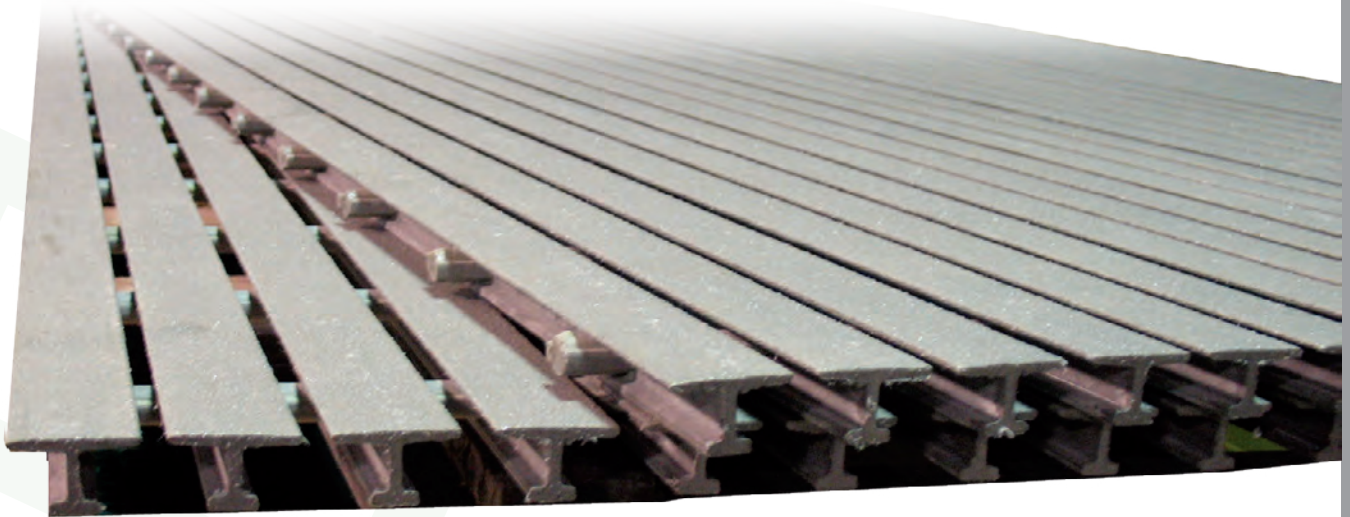

The load bars are held together using tie-bars (see picture below) and bonded with a high strength glue. The shape of the load bars, as well as the higher glass content compared to molded grating, create a stronger and more rigid grating in the direction of the load bars. Pultruded grating has uni-directional strength, as the tie-bars are not designed to carry load. Special care must be taken when designing catwalks, platforms, and stair tread to orient the load bars in the correct direction.

The higher strength rating of pultruded grating makes it ideal for applications that have larger spans and additional structural support cannot be added. Pultruded grating is often used as a direct replacement for steel grating due to the similar load bar configuration and load characteristics.

Like molded grating, pultruded grating is lightweight and easy to fabricate, reducing installation costs. The standard anti-slip grit top surface improves safety in industrial settings where slip/fall accidents can be very costly.

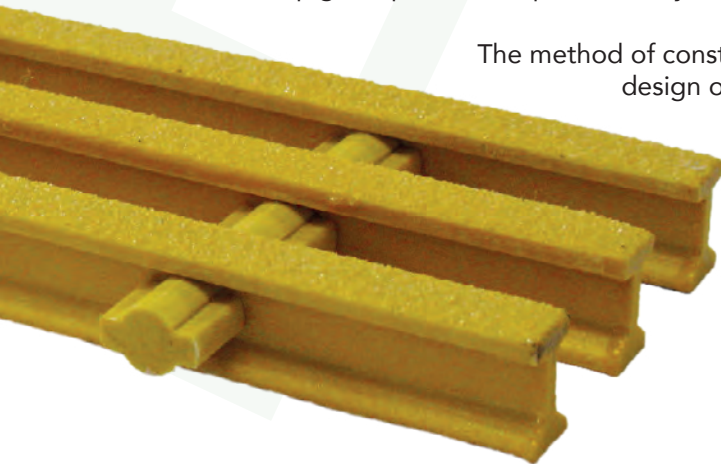

The method of construction of pultruded grating allows for much flexibility in the design of a panel. Pultruded grating can be manufactured in almost any panel size by adding or subtracting load bars. Load bars can be manufactured in almost any length, only limited by practical constraints, such as panel weight or transportation. Load bars can be positioned closer together or farther apart to change the open area of the grating. The potential combinations are almost limitless!

## Pultruded Grating

VersaGrate pultruded grating comes in a wide variety of options, including resins, colors, grits, panel sizes, open areas, and thicknesses.

Two basic resins are available: PFR- 25 and VFR- 25 (see page 4). The most common color for pultruded grating is safety yellow, although light and dark gray are also common. Post-cure grit is standard on all pultruded grating although it can be ordered without grit.

Pultruded grating is often designated by its open area, which is determined by the load bar spacing. Common open areas include 40%, 50%, and the economical 60%. The load bars are also designated either an "I" bar or a "T" based on the shape of its profile. A "T" shaped bar normally is used for a very small open area, such as 33%. See the selection chart below for more details.



Type	Depth	Open Area	Standard Panel Size	Weight Per Sq. Ft.
I-6010	1"	60%	4' X 12', 4' X 20'	2.63
I-5010	1"	50%	4' X 12', 4' X 20'	3.05
I-4010	1"	40%	4' X 12', 4' X 20'	3.43
T-3310	1"	33%	4' X 12', 4' X 20'	2.10
T-3810	1"	38%	4' X 12', 4' X 20'	1.94
I-6015	1½"	60%	4' X 12', 4' X 20'	2.83
I-5015	1½"	50%	4' X 12', 4' X 20'	3.53
I-4015	1½"	40%	4' X 12', 4' X 20'	4.13
T-5020	2"	50%	4' X 12', 4' X 20'	3.10
T-3320	2"	33%	4' X 12', 4' X 20'	4.03

Standard options: 6" tie bar spacing, grit top surface, ASTM flame spread rating of 25 or less. Other options are available for special order.



## Structural Shapes

VersaGrate offers a wide selection of structural shapes to complement our line of fiberglass grating. Fiberglass structural shapes have one of the highest strength-to-weight ratios of any structural product, as well as superior corrosion resistance.

Fiberglass structural shapes are manufactured using the pultrusion process. Glass mat and roving are drawn through a resin bath and pulled through a heated die to form the desired shape. This process can yield almost any profile shape commonly used in structural framework.

Fiberglass structural shapes are dimensionally stable, as well as thermally and electrically non-conductive. Being easy to fabricate as well as lightweight, fiberglass structural shapes are also easy to install, reducing costs associated with special lift equipment and tools.

VersaGrate structural shapes are available in a wide variety of shapes, including I-beam, equal leg angle, unequal leg angle, channel, square tube, and round tube. Concrete embedment angle is also available in a variety of sizes for use in areas where traditional metal embedment angle may corrode prematurely.

Fiberglass structural shapes are available in VersaGrate's two main resins: PFR-25, a premium polyester resin, and VFR-25, a vinylester resin with superior corrosion properties (see page 4). Both resins have a standard ASTM flame spread rating of 25 or less.

Please call for more information about the wide variety of shapes available, or contact your local distributor.



## Fabrication

VersaGrate's ease of fabrication is a key benefit, saving both time and money versus metal grating. VersaGrate offers fabrication services as an aid to end users. However, most end users prefer to cut the grating onsite to ensure accuracy and to allow for field adjustments.

VersaGrate recommends the following safety procedures when fabricating fiberglass grating.

- Always wear safety glasses and gloves when handling and cutting fiberglass grating. Dust from cutting fiberglass is an irritant to skin, eyes, and the respiratory system.
- Always wear an approved mask and cover skin appropriately to minimize irritation.

VersaGrate fiberglass grating only requires basic tools to fabricate. Fiberglass grating is similar in fabrication characteristics to wood. A power saw, such as a worm-gear circular saw, equipped with a masonry or diamond blade is ideal for cutting fiberglass grating.

Cutting with the grit top facing down also aids in making clean, straight cuts. Use smooth even pressure, and be sure to take your time. Always seal cuts with a high quality resin sealant to protect exposed glass. This sealant can be purchased from VersaGrate at the time of your grating order, but must be shipped common carrier.

For best results, plan your project so that cuts land next to load and cross bars. Keep in mind the kerf, or width, of the blade when laying out your project.

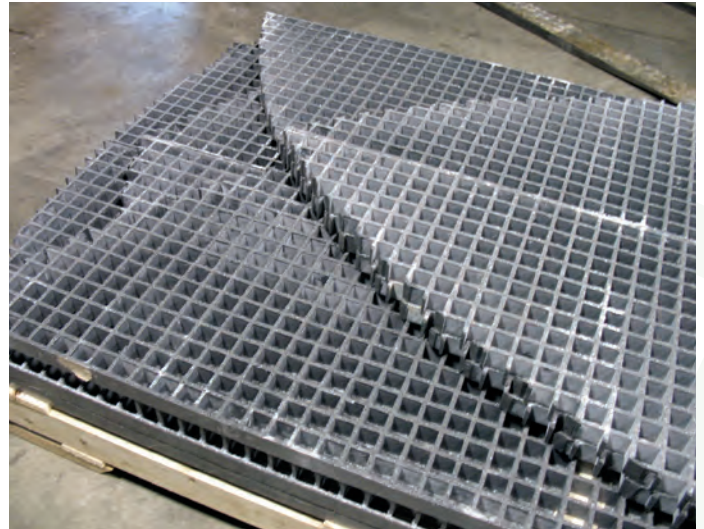



# Fiberglass Structures

VersaGrate also offers fiberglass platforms, handrails, ladders and stairwells.

## Custom Platforms

Each platform is custom designed for each unique application. CAD design software is used to ensure accuracy and allow for flexibility in the design process.

All platforms are completely assembled and tested before shipment to ensure proper fitment, and are then broken down for shipment purposes. All pieces are clearly marked for effortless field installation.

Structural fiberglass is lightweight, which allows for easier installation and reduced shipping costs. Fiberglass is naturally corrosion resistant, reducing maintenance and prolonging the life of the platform. Being unaffected by cleaning agents, it is ideal for wash-down applications in the food and dairy industry. The safety yellow fire-retardant resin improves visibility and safety, and non-slip grit surfaces can be applied where needed. All platforms meet or exceed OSHA and IBC standards.

- Non-Conductive — Heat and Electric
- Maintenance Free
- Light Weight
- High Strength
- Corrosion Resistant
- Safety Yellow Color
- Non-slip UltraGrit™ surface
- Fire Retardant
- Exceeds OSHA and IBC standards
- Ideal for wash-down in food applications per NSF



# Fiberglass Structures

## Fiberglass Ladders

All fiberglass ladders are custom built for access on catwalks, mezzanines, tanks, and roofs. All ladders are built to meet or exceed OSHA specifications.

Ladders can be made with safety cages, safety rails & trollies, removable sections, and walk-throughs. Whatever the application requires!

- Corrosion Resistant
- Safety Yellow Color
- Maintenance Free
- Non-skid grit-coated rungs
- Light Weight
- Non-Conductive-Heat & Electric
- Per OSHA and ANSI Standards
- Exceeds 1200 lbs duty rating

## Custom Handrail

Handrail is custom built from common industry components, such as M-style kickplates, square fiberglass tube, and solid bar to create a uniform look, as well as a rugged and strong hand-rail system. Shipped in assembled sections up to 20' long, fiberglass handrail is ideal for existing stairways, walkways, and platforms, or as a complement to new fiberglass structures.

- Non-Conductive — Heat and Electric
- Maintenance Free
- Light Weight
- High Strength
- Corrosion Resistant
- Safety Yellow Color
- Fire Retardant
- Exceeds OSHA and IBC Standards

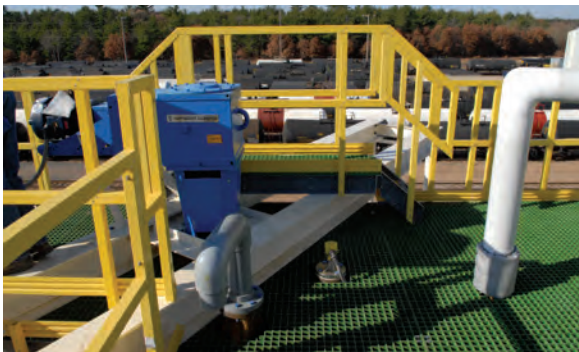



# Part Number Matrix

## 1 – 2 3 4 – 5 – 6 – 7 – 8

<b>1: TYPE</b>	M – Molded P – Pultruded	<b>5: PANEL SIZE</b>	A – 4' x 12' B – 4' x 8' E – 3' x 10' K – 22 <sup>3</sup> / <sub>4</sub> " x 12' H – 5' x 10' D – 4' x 20'
<b>2: MESH 1</b>	10 – 1" 15 – 1½" 20 – 2" 40 – 4"	<b>6: RESIN</b>	P – PFR-25 V – VFR-25 F – FFR-25
<b>3: MESH 2</b>	10 – 1" 15 – 1½" 20 – 2" 40 – 4"	<b>7: COLOR</b>	GRN – Green LGY – Light Gray YEL – Yellow DGY – Dark Gray
<b>4: THICKNESS</b>	05 – ½" 10 – 1" 11 – 1 <sup>1</sup> / <sub>8</sub> "* 12 – 1 <sup>1</sup> / <sub>4</sub> " 15 – 1½" 16 – 1 <sup>5</sup> / <sub>8</sub> "* 20 – 2" 21 – 2 <sup>1</sup> / <sub>8</sub> "*	<b>8: SPECIALS</b>	P – Post-cure Grit M – Meniscus Top

\* Covered grating thickness only.

### EXAMPLE 1:

- Molded – 1½" square mesh – 1" thick – 4' x 12' panel – PFR-25 resin – Green color:  
**M-151510-A-P-GRN**

### EXAMPLE 2:

- Molded – 1" x 4" rectangular mesh – 1" thick – 3' x 10' panel – PFR-25 resin – Light Gray color:  
**M-104010-E-P-LGY**

**NOTE:** Not all options are available on all product lines.

Catalog A0313

Copyright 2013 VersaGrate Fiberglass Grating. VersaGrate name, logo and VersaTread name are trademarks. All rights reserved. Printed in the USA



# **VersaGrate™**



**VersaGrate Fiberglass Grating**  
**1834 Morrow Street**  
**Green Bay, WI 54302**  
**877.GRIT.TOP (877.474.8867)**  
**920.469.4167 (fax)**  
**[www.versagrate.com](http://www.versagrate.com)**